

DOCCIA IDROMASSAGGIO

INDY

Box doccia idromassaggio

In questo manuale è illustrata la procedura di montaggio della **cabina doccia idromassaggio** .
Prima di effettuare il montaggio consigliamo di consultare il presente manuale di istruzioni per effettuare un montaggio a regola d'arte.

Per visionare tutti i modelli di **docce idromassaggio** visita la sezione

[DOCCIA IDROMASSAGGIO](#)

Per acquistare la **doccia idromassaggio** Indy clicca
SU

[Box doccia idromassaggio 80x80](#)

[Box Doccia Idromassaggio 90x90](#)

Misure box doccia

800 × 800 × 2250mm

900 × 900 × 2250mm

Per richiedere un ricambio o un accessorio del **box doccia** clicca su

[**ASSISTENZA IMPORT FOR ME**](#)

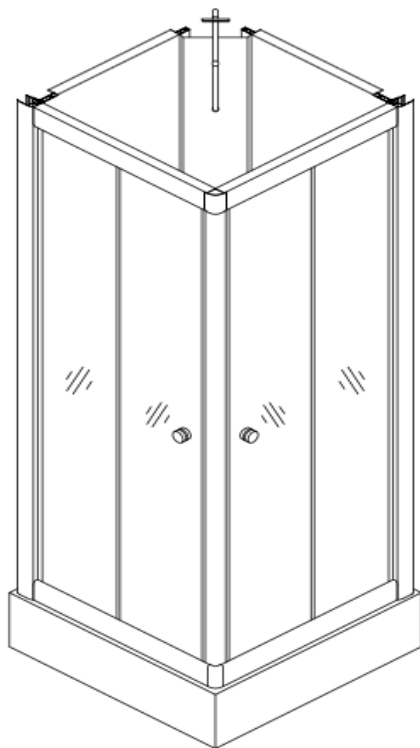

1/4

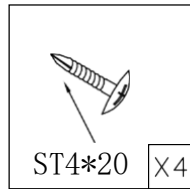
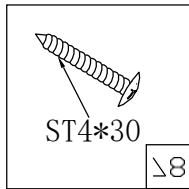
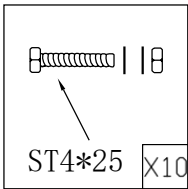
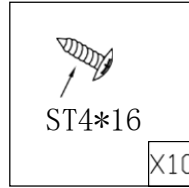
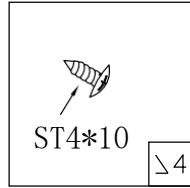
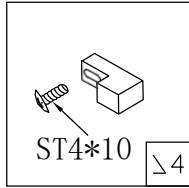
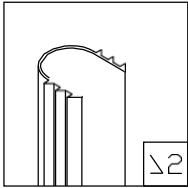
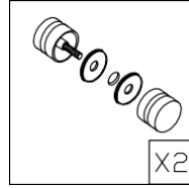
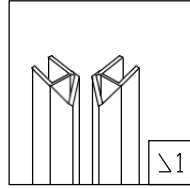
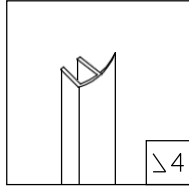
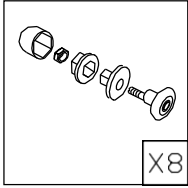
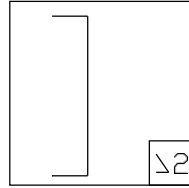
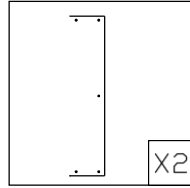
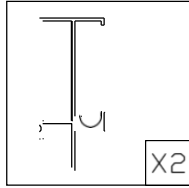
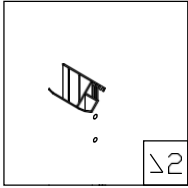
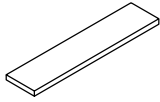

2/4

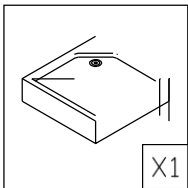
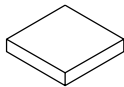

3/4

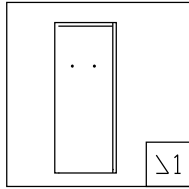
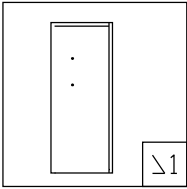
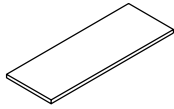

4/4

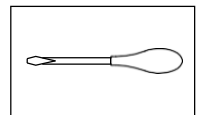
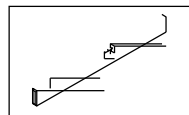
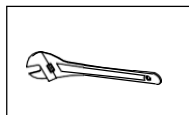
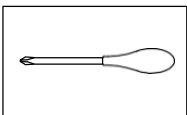
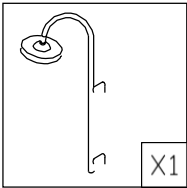
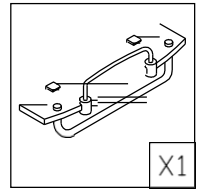
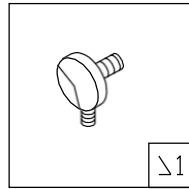
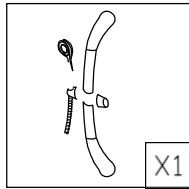
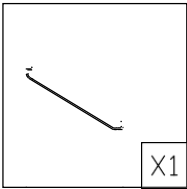
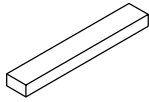

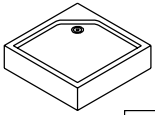

X1

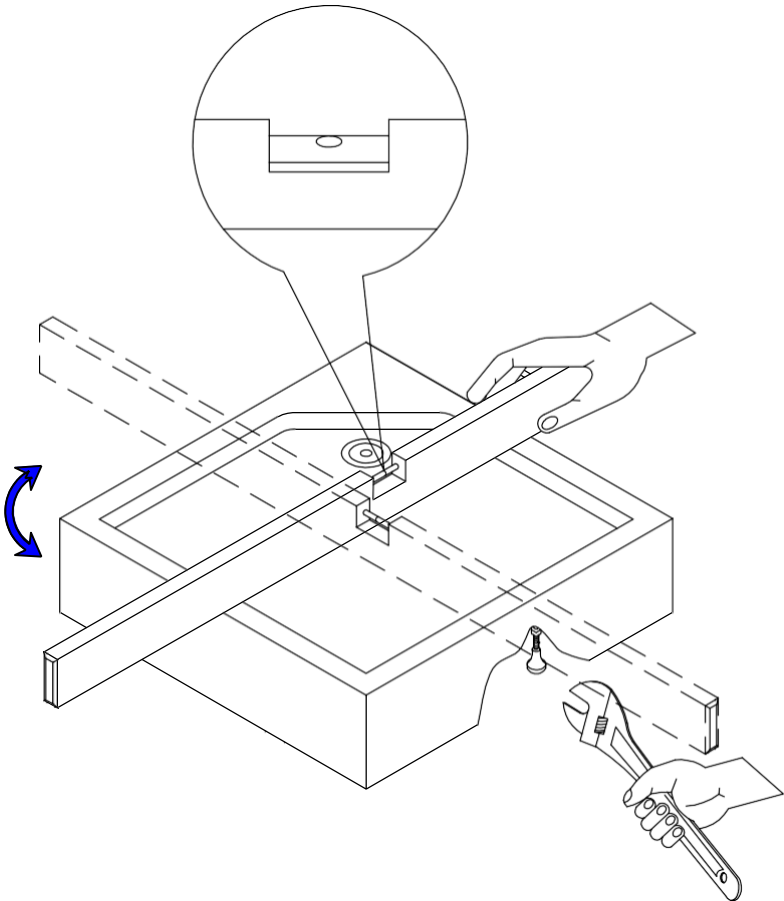
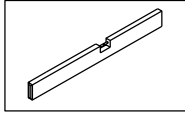
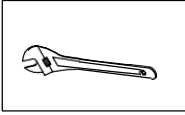

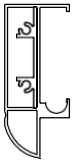

X2



ST4*10

X4

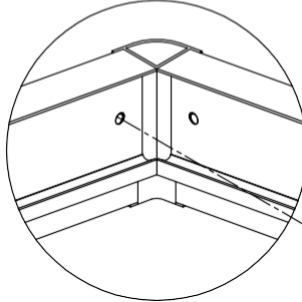
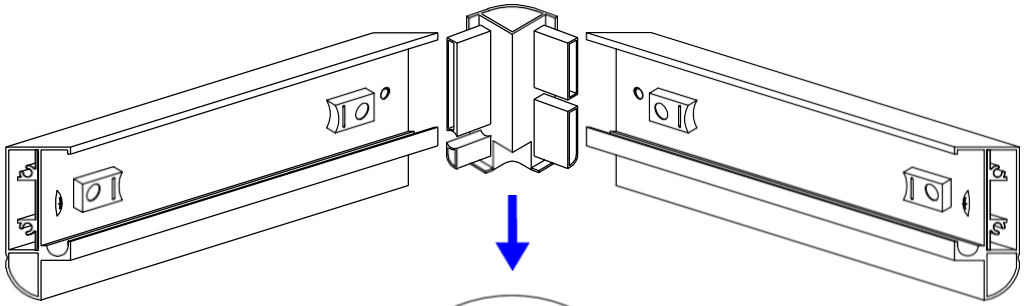
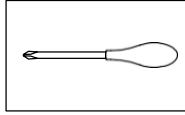

4- \varnothing 2.8mm

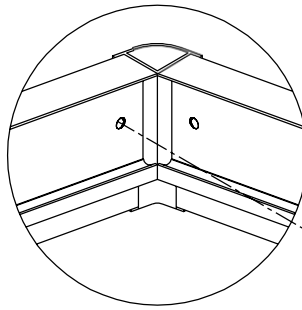
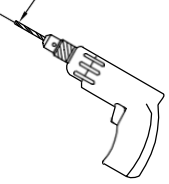

ST4*10

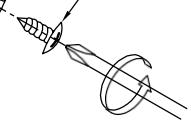

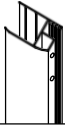

X2

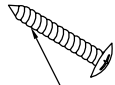

ST4*30

X8

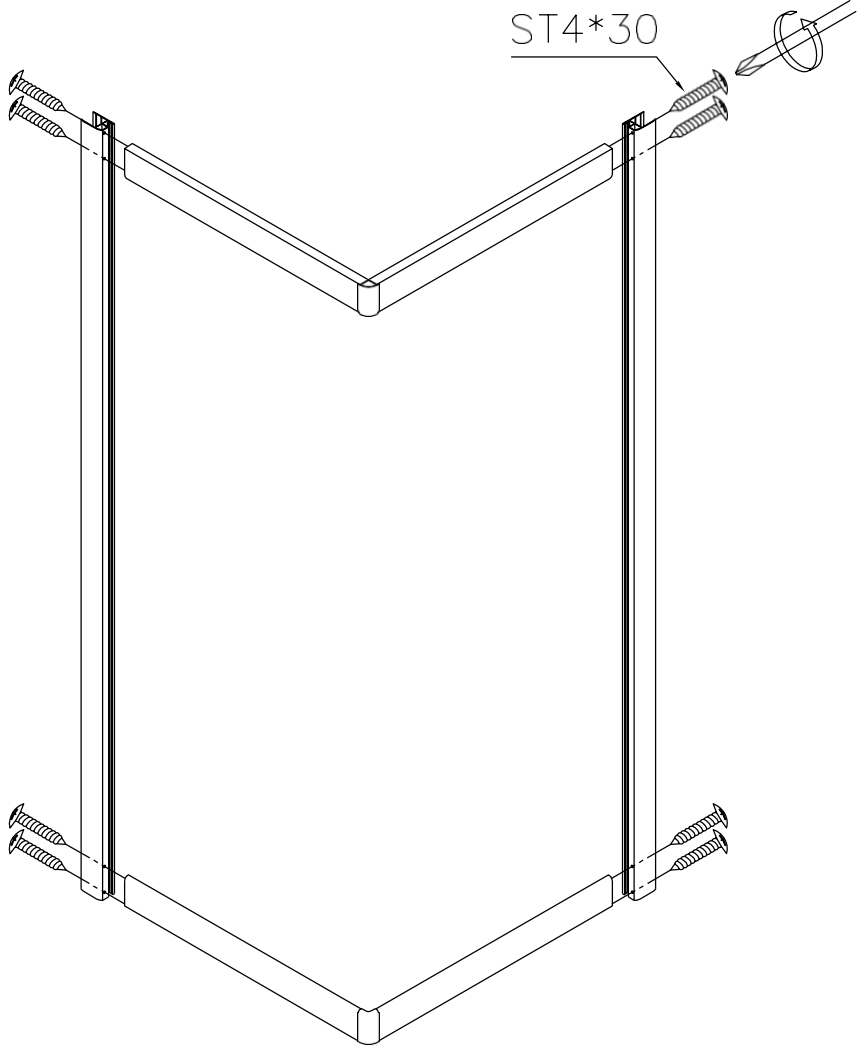
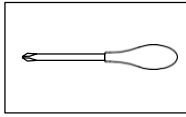

ST4*30

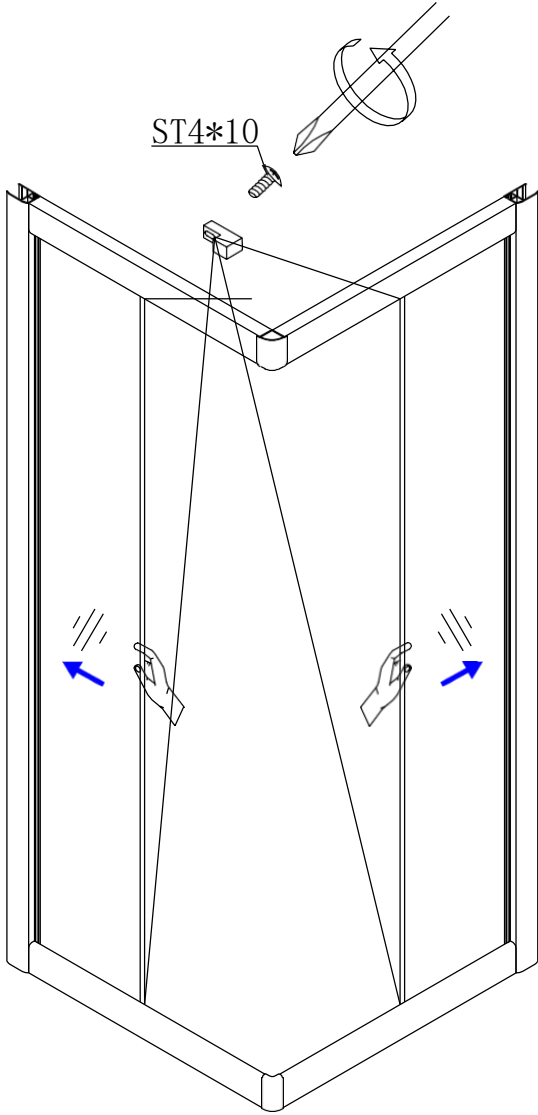
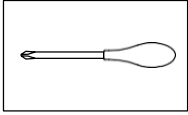
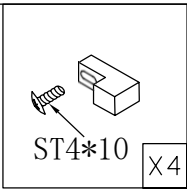
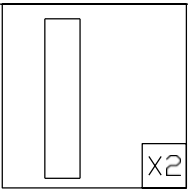
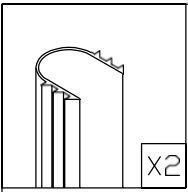

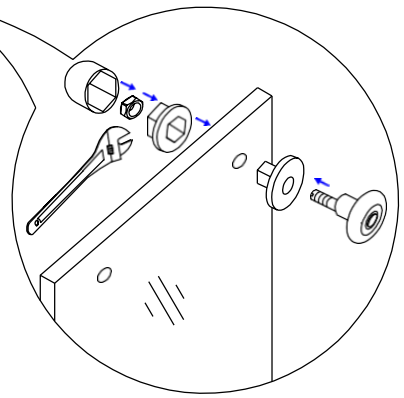
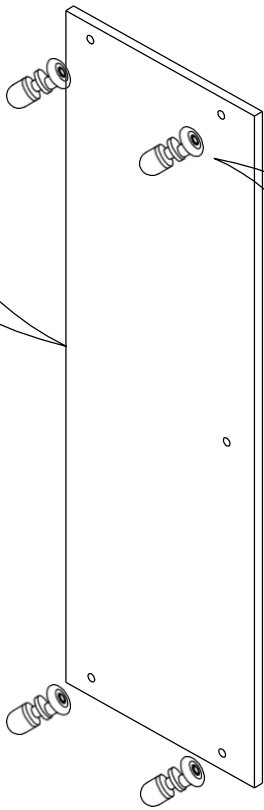
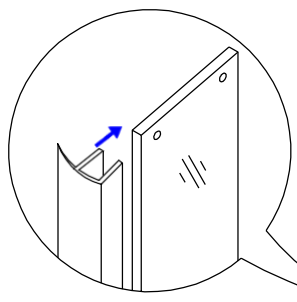
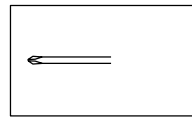
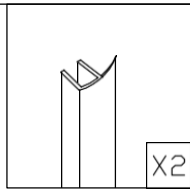
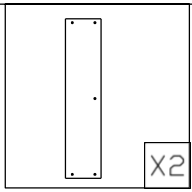
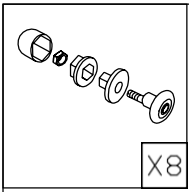

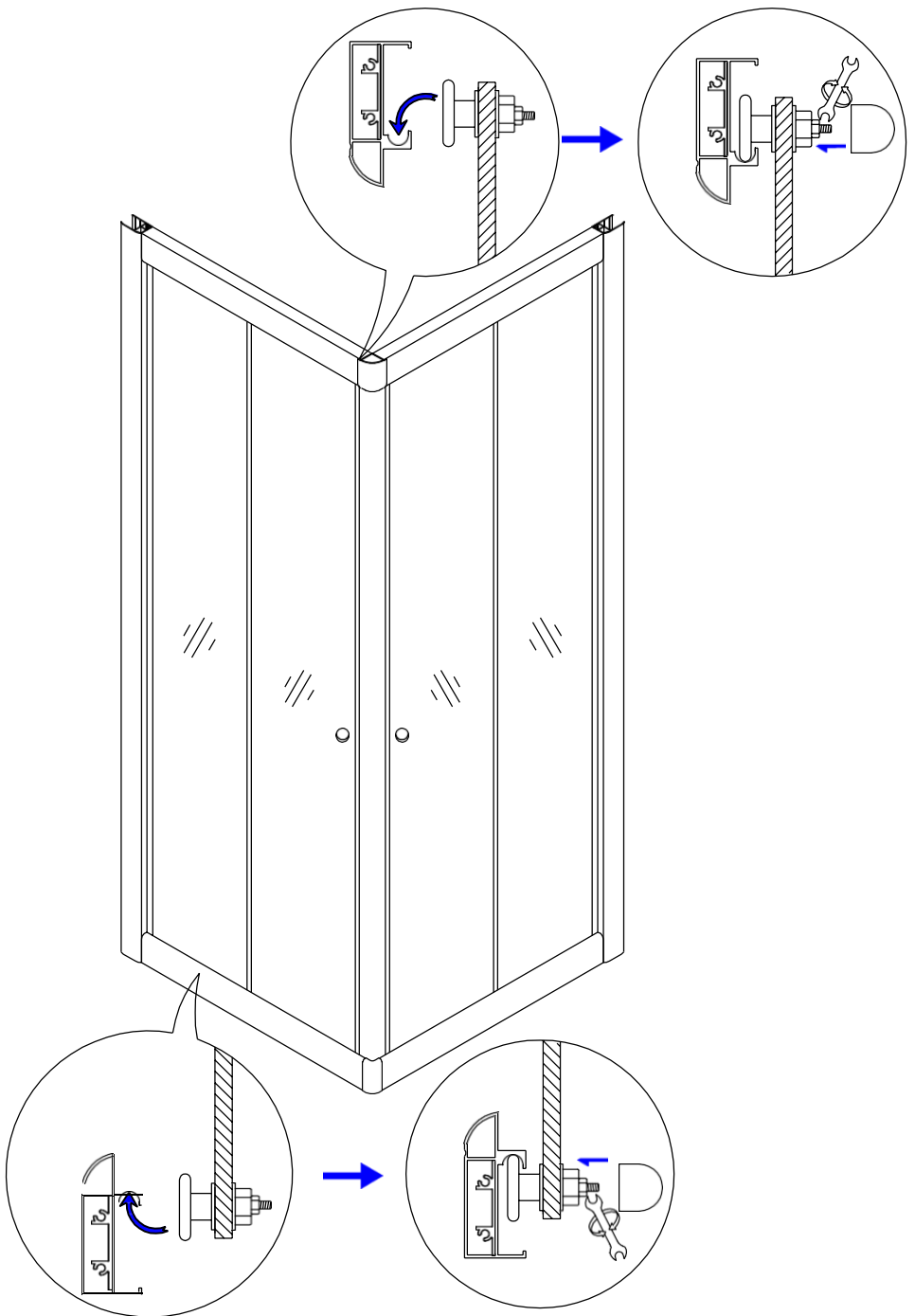

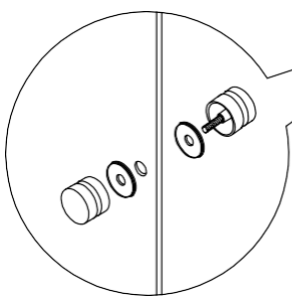
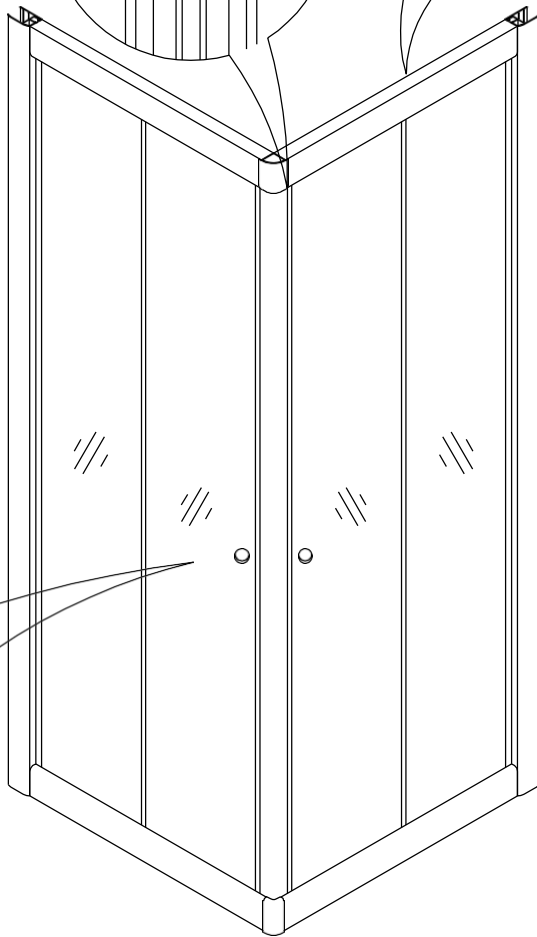
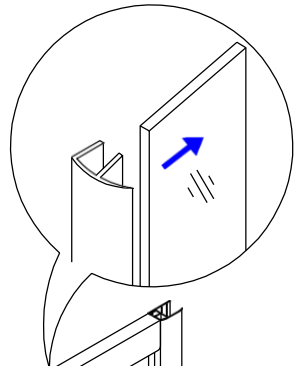
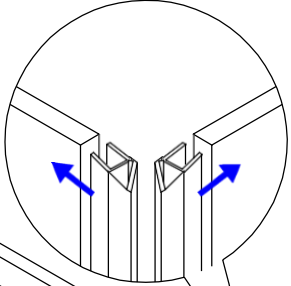
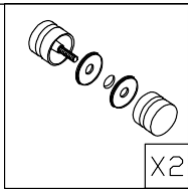
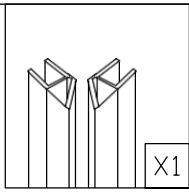
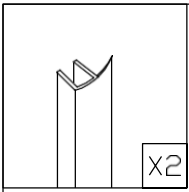

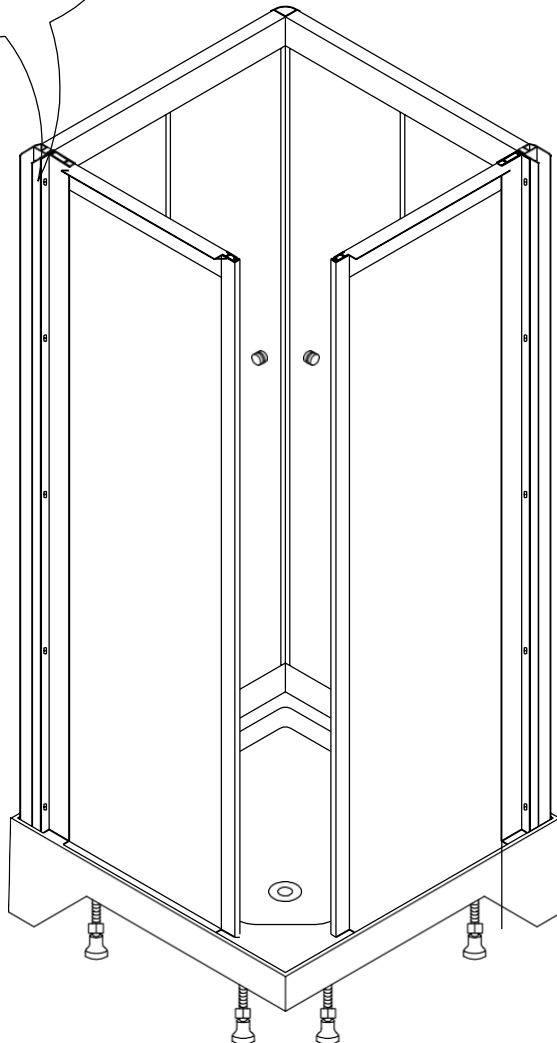
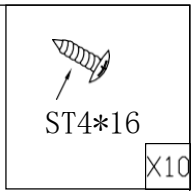
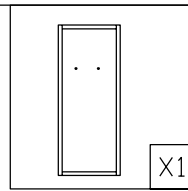
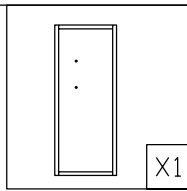
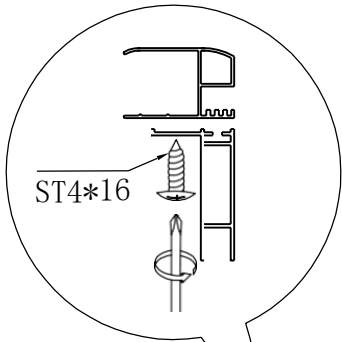

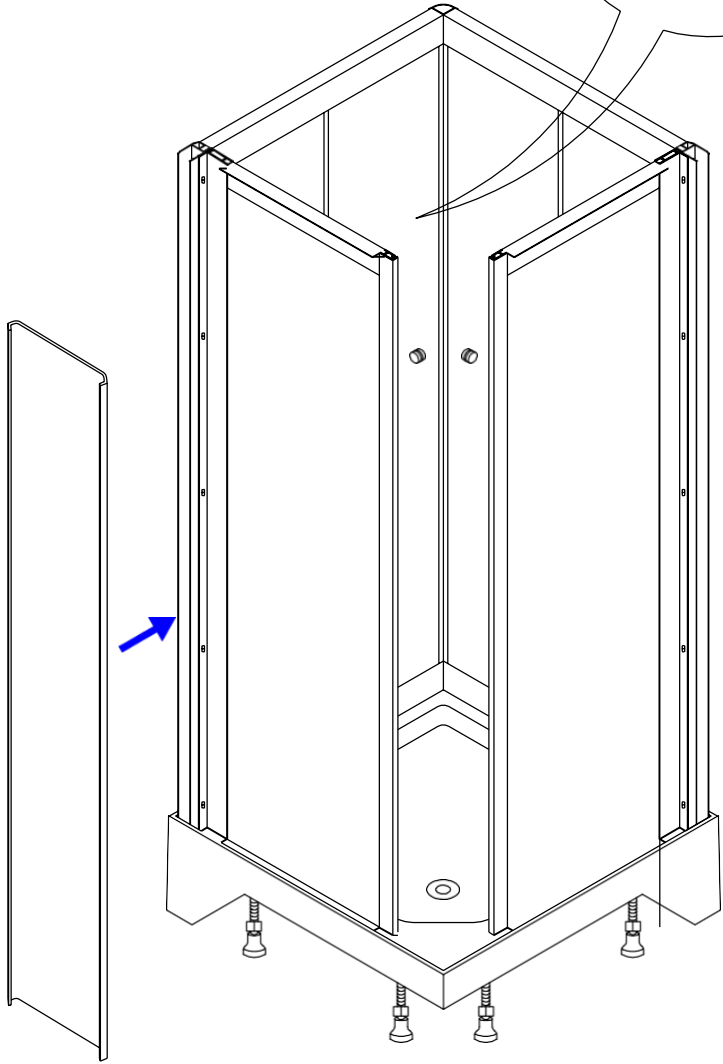
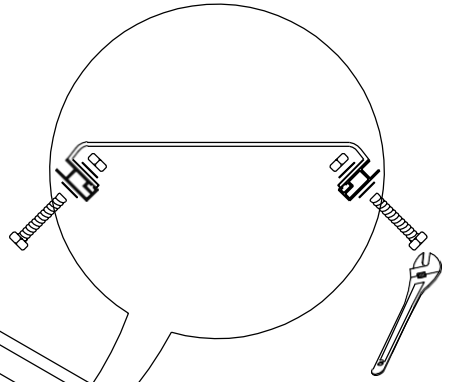
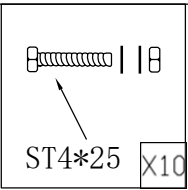
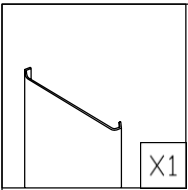



ST4*20 X4

4-ST4*20

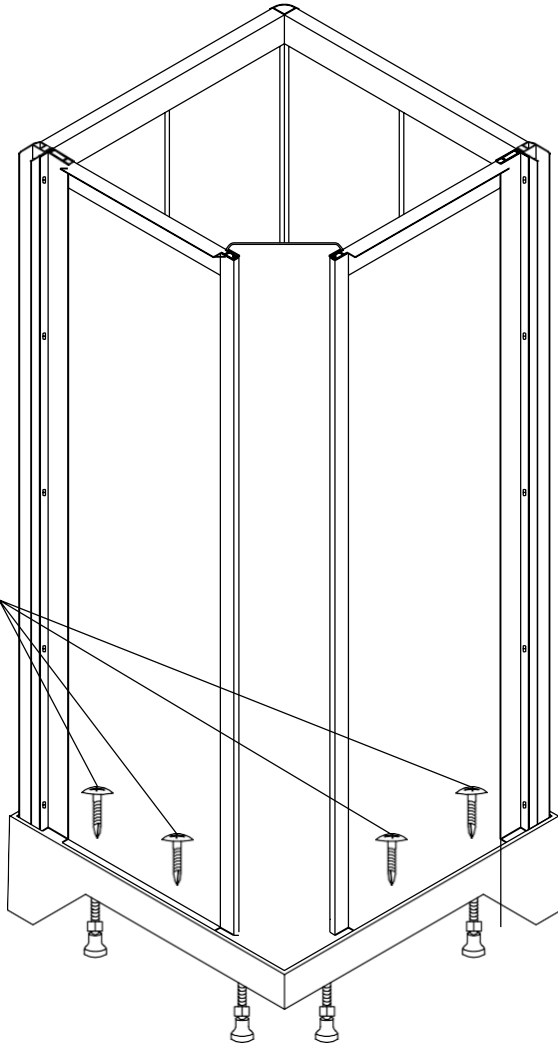

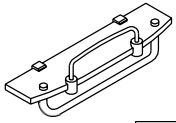

X1

